

Serie Heavy

307SU

Replace 307SI/SE Series

Nylon Cable Chain with opening frames

Inner height (D) 47 mm

Strong double share Sideband & Frame construction with large anti-friction triple-pin. Frames opening from inner and outer radius.

As standard the chain comes with frames every second link, on request with frames every link.

Vertical and horizontal modular separator system is available.

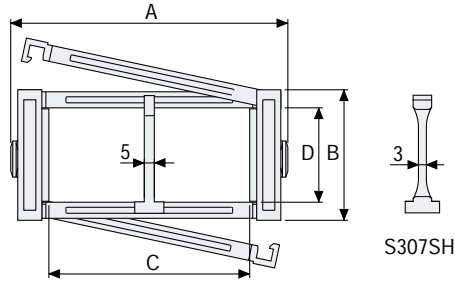

Separator

- Unassembled	Part.no S307S
- Assembled*	Part.no S307SMCI
- Assembled**	Part.no S307SMCE

Strong-hold separator

for C > 250 mm

- Unassembled	Part.no S307SH
- Assembled*	Part.no S307SHMCI
- Assembled**	Part.no S307SHMCE

Pin

Part.no PG307

* for chain opening outer radius

** for chain opening inner radius

Technical characteristics when self-supported

Speed	8 m/s
Acceleration	40 m/s ²

For higher requirements please consult our technical dept.

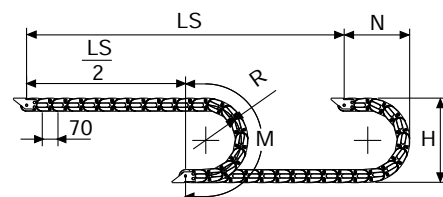

Length of chain (L)

Half travel distance ($\frac{LS}{2}$)

plus length of curve (M)

$$L = \frac{LS}{2} + M$$

R	H	N	M
mm	mm	mm	mm
075	219	180	375
090	249	195	425
120	309	225	520
140	349	245	580
200	469	305	770
250	569	355	925

A	B	C	D	R	Weight/m	Chain
mm	mm	mm	mm	mm	kg	Part Number
80	65	42	47	075-090-120-140-200-250	1,86	307SU042 □□□ *
91	65	53	47	075-090-120-140-200-250	1,86	307SU053 □□□ *
105	65	67	47	075-090-120-140-200-250	1,92	307SU067 □□□ *
111	65	73	47	075-090-120-140-200-250	1,94	307SU073 □□□ *
115	65	81	47	075-090-120-140-200-250	1,96	307SU077 □□□ *
125	65	87	47	075-090-120-140-200-250	1,97	307SU087 □□□ *
130	65	92	47	075-090-120-140-200-250	1,97	307SU092 □□□ *
137	65	99	47	075-090-120-140-200-250	1,99	307SU099 □□□ *
147	65	109	47	075-090-120-140-200-250	2,00	307SU109 □□□ *
155	65	117	47	075-090-120-140-200-250	2,05	307SU117 □□□ *
166	65	128	47	075-090-120-140-200-250	2,07	307SU128 □□□ *
180	65	142	47	075-090-120-140-200-250	2,10	307SU142 □□□ *
205	65	167	47	075-090-120-140-200-250	2,16	307SU167 □□□ *
230	65	192	47	075-090-120-140-200-250	2,23	307SU192 □□□ *
241	65	203	47	075-090-120-140-200-250	2,26	307SU203 □□□ *
255	65	217	47	075-090-120-140-200-250	2,30	307SU217 □□□ *
282	65	244	47	075-090-120-140-200-250	2,37	307SU244 □□□ *
291	65	253	47	075-090-120-140-200-250	2,39	307SU253 □□□ *
342	65	304	47	075-090-120-140-200-250	2,50	307SU304 □□□ *
364	65	326	47	075-090-120-140-200-250	2,56	307SU326 □□□ *
392	65	354	47	075-090-120-140-200-250	2,63	307SU354 □□□ *

*Complete the code by inserting the value of the radius (R): Ex. 307SU117 □□□□

Chain equipped with nylon frame every pitch: complete the code by inserting the letter D.

Ex. 307SU117140 □□

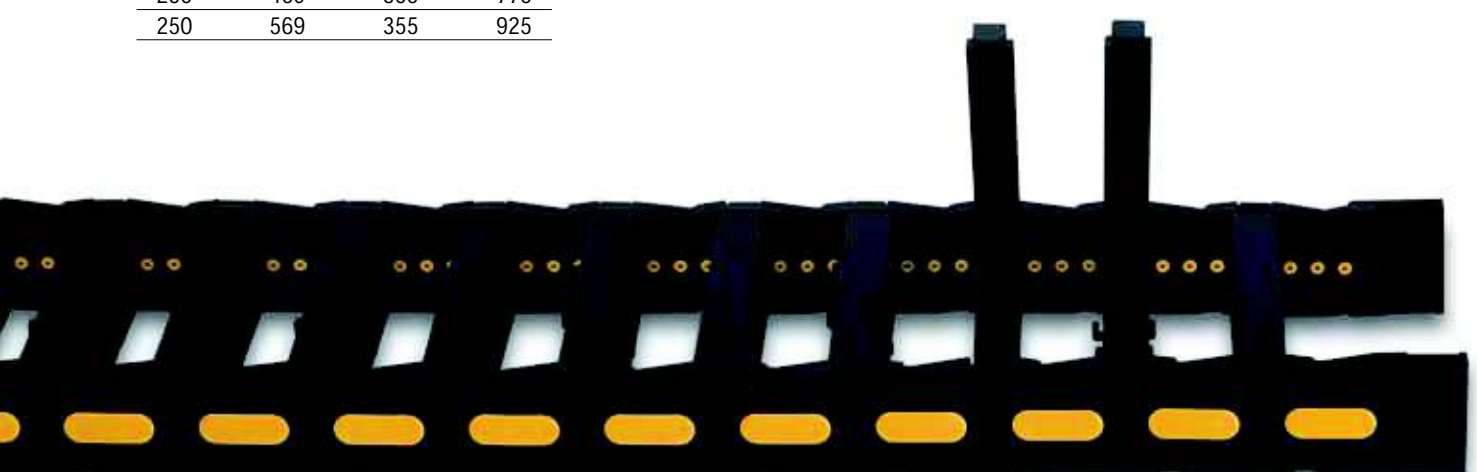

Self-Supporting Capacity Diagram

The maximum length of the self-supporting capacity ($\frac{LS}{2}$) in relationship to the weight of the cables and hoses contained per linear metre.

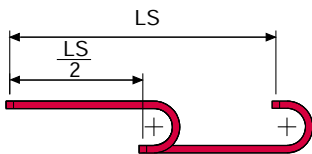
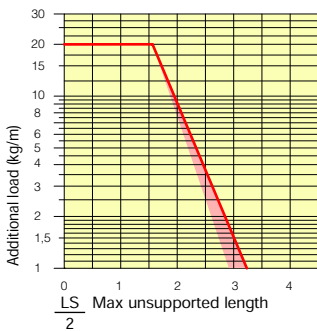

The red marking in the diagram area considers the difference of weight between various widths of chains assembled with nylon frames every second pitch.

For applications with $\frac{LS}{2}$ and weights not included in the area of the diagram showing self-supporting capacity, verify the possible use of support rollers (see page 30).

End Brackets

The end brackets set allows the two ends of the chain to be attached to the equipment. Set complete with tiewrap clamps available on request.

Nylon Type

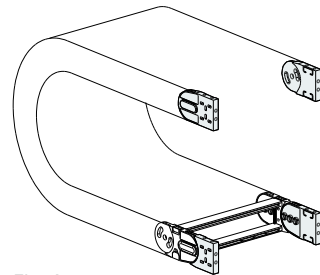

Fig. A
The chain can be fixed frontally, inner or outer radius. (Fig A)

Bright Zinc Plated Steel Type***

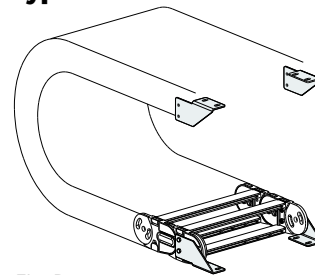
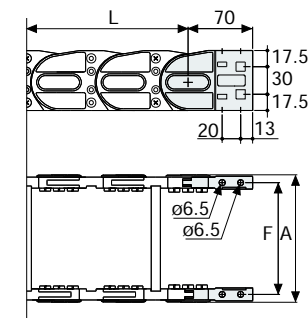

Fig. B
Chain fixed outside the radius. (Fig B)
See end brackets mounting variations page 31.



Chain Type	F mm
307SU042	61
307SU053	72
307SU067	86
307SU073	92
307SU081	100
307SU087	106
307SU092	111
307SU099	118
307SU109	128
307SU117	136
307SU128	147
307SU142	161
307SU167	186
307SU192	211
307SU203	222
307SU217	236
307SU244	263
307SU253	272
307SU304	323
307SU326	345
307SU354	373

Nylon Type Part Numbers

Complete Set Assembled Chain Type	End Brackets Set
307SU...	AN307KM

Complete Set Unassembled Chain Type	End Brackets Set
307SU...	AN307K

Tiewrap Clamp
Assembl. CFC307S □□□ *KM
Unassembl. CFC307S □□□ *K

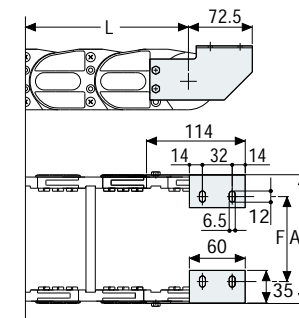

Chain Type	F mm
307SU042	31
307SU053	42
307SU067	56
307SU073	62
307SU081	70
307SU087	76
307SU092	81
307SU099	88
307SU109	98
307SU117	106
307SU128	117
307SU142	131
307SU167	156
307SU192	181
307SU203	192
307SU217	206
307SU244	233
307SU253	242
307SU304	293
307SU326	315
307SU354	343

Bright Zinc Plated Steel Type Part Numbers

Complete Set Assembled Chain Type	End Brackets Set
307SU...	A307SK □**

Complete Set Unassembled Chain Type	End Brackets Set
307SU...	A307SK □**

Tiewrap Clamp
Assembl. SFCT307S □□□ *KM
Unassembl. SFCT307S □□□ *K

* Inner width (C)
** 1=Pos.1; 2=Pos.2; 3=Pos.3
*** Available on request in stainless steel

Serie Heavy

307SU

Nylon Cable Chain with opening frames

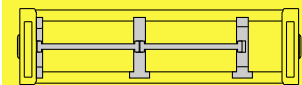

Separation System
To choose the separators see page. 199



How to open the cover.

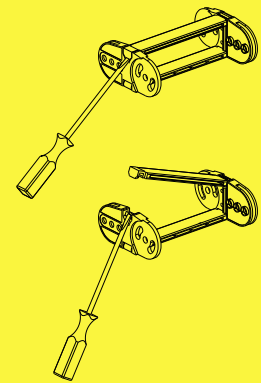

Special tool to remove the connecting pivots:
Part Number PZ036.



For further information please consult Brevetti Stendalto's Technical Office